

SECTION A-A

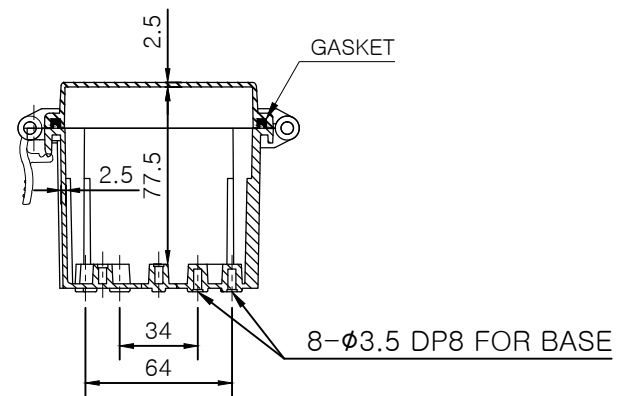
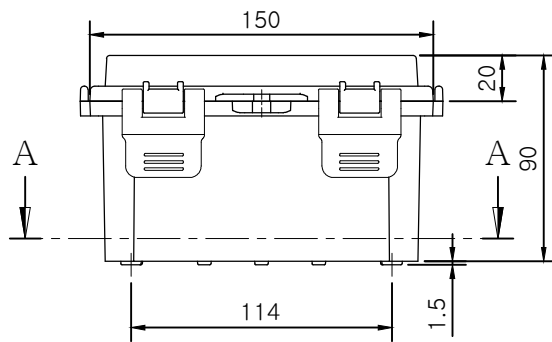

SECTION B-B

Note.

*규격 및 사양은 사전 예고 없이 변경 될 수 있습니다.
 *Specifications and Dimentions are subject to change without notice.

MODEL (모델)	BC-□□Q-101509			D R (제 도)	HWANG,S.M.	21.07.15	UNIT (단 위)	mm
ASSY (완성 규격)	100 * 150 * 90			C K (검 도)	KIM,S.J.	21.07.15	SCALE (척 도)	1:1
DWG NO (도 번)	Q-101509	MATERIAL (재 질)		A P (승 인)	KIM,S.J.	21.07.15	REV. (개 정)	0

